

ELECTRODE SETTING

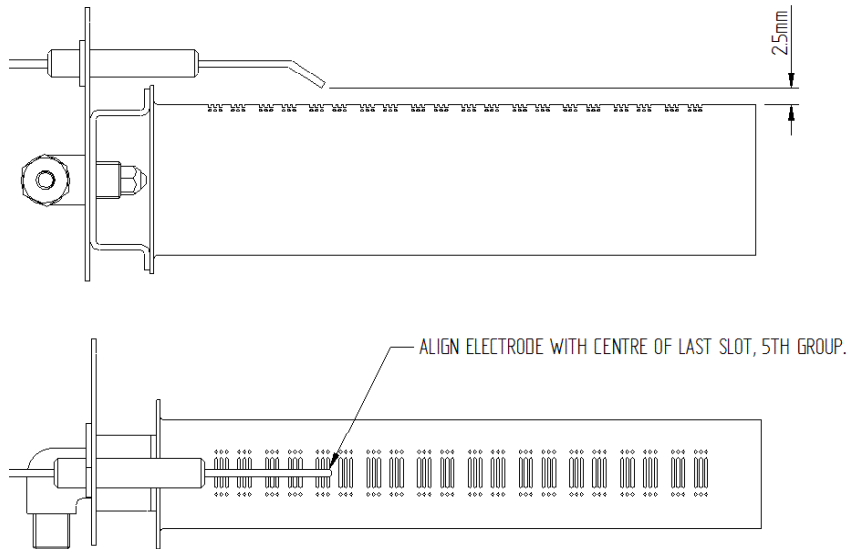

All gas appliances must be installed and/or commissioned by persons registered with the Gas Safety Register (GB) or the relevant national organisation.

Manufactured by:

Munster Simms Engineering

Distributed by:

PROPEX HEATSOURCE LTD

Unit 5, Second Avenue Business Park,
Millbrook, Southampton,
United Kingdom, SO15 0LP

Tel: 023 8052 8555

Fax: 023 8052 8800

Website: www.propexheatsource.co.uk
E.mail: info@propexheatsource.co.uk

Ref No: 180.119

ISSUE 1



INSTALLATION & OPERATION INSTRUCTIONS

Malaga 5/5E Storage Water Heater



0120

USER INSTRUCTIONS

Read the User Installation and Operation Instructions carefully before using this product.

This appliance is not intended for use by persons (including children) with reduced physical, sensory or mental capabilities, or lack of experience and knowledge, unless they have been given supervision or instruction concerning use of the appliance by a person responsible for their safety. Children should be supervised to ensure that they do not play with the appliance.

All warnings should be observed.

Incorrect use of the appliance and non observation of the installation and operator instructions shall lead to the cancellation of the warranty and exclusion of liability claims. Only use the heater as directed by these instructions.



This symbol indicates that this appliance is suitable for use in Leisure Accommodation Vehicles.



This symbol indicates that this appliance is not suitable for use in boats.

CONTROL PANELS

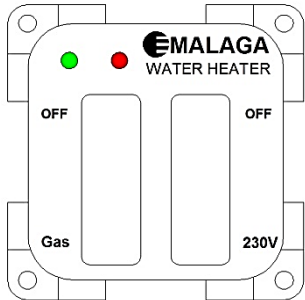

Malaga 5 E Control Panel
2 x 2 Position Switch
Green operation LED
Red lockout LED

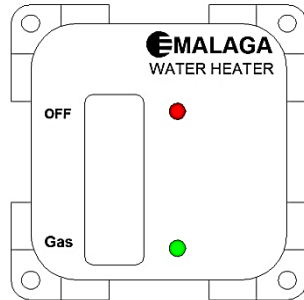

Malaga 5 Control Panel
1 x 2 Position Switch
Green operation LED
Red lockout LED

WIRING DIAGRAM MALAGA 5/5E

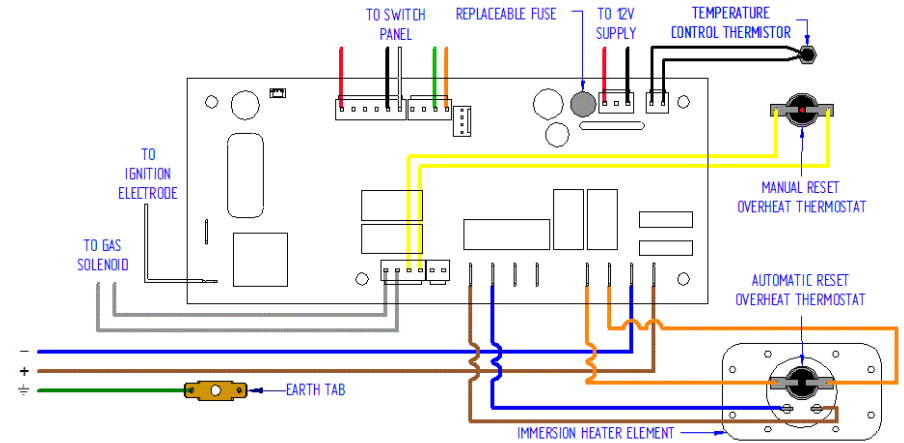

MALAGA 5/5E CONTROL LOOM

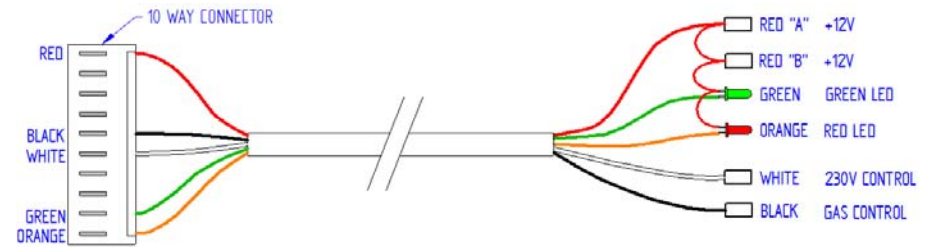

Note: Malaga 5 (Gas only) does not have the white wire or the +12V "B" connection.

MALAGA 5/5E SWITCH PANEL CONNECTIONS



MALAGA 5 /5E POWER LOOM

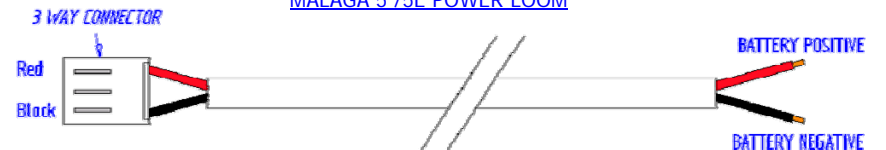

TECHNICAL DATA

- **Dimensions**
 - Height – 250mm
 - Width – 285mm
 - Depth – 520mm
- **Weight empty** 9.3kg
- **Nominal Water capacity** 13 Litres
- **Inward protrusion from wall** 480mm
- **HEATING TIMES**
 - Gas Approx. 43 Mins
 - 15 °C– 70°C Gas & Electric Approx. 28 Mins
 - Electric Only Approx. 64 Mins
- **Standby consumption Gas** 98W
- **WATER - Maximum supply pressure** 1.3 BAR
 - Pressure relief valve setting 3.0 BAR
 - Working pressure 2.0 BAR
- **GAS**
 - Heat input 1.25kW / 91g/h
 - Injector Bray 960 / 40
 - Gas connection 8mm / 5/16 o.d.
 - Gas type Butane 28-30mBAR
 - Propane 37mBAR
 - Pressure category & pressure I₃₊ (28-30/37)
 - I_{3B/P} (30)
- **ELECTRICITY –Malaga 5** 12V DC
 - Malaga 5E 12V DC + 230V AC element
 - Element 750W
 - Current consumption @ 12V 0.36A

Note: If connecting to mains water supply, a suitable water pressure regulator must be connected to ensure that the maximum supply of water pressure does not exceed 190kPa (1.9bar)

Clearances required for installation and servicing, as seen from the inside.

Left Hand Side	240mm
Right Hand Side	100mm
Top	5mm

PRESSURE RELIEF/DRAIN VALVE

When not in use the heater should be drained using the drain valve as per the diagram.

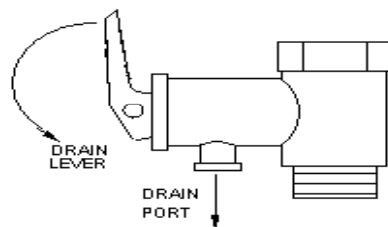

OPERATION INSTRUCTIONS

- **The Propex Malaga 5 is for use on L.P.G. only.**
- **The Propex Malaga 5E is for use on both L.P.G. and mains electricity.**

On initial operation or when the system has been drained, refill the system with water and flush out by turning on each hot tap until a steady flow of water is obtained. If a water filter is fitted it should be changed at the recommended intervals.

Check that all the gas and electricity supplies are turned on.

GAS – Switch to the gas position on the control panel. Initially no LED will come on and there will be a 10 second delay. Ignition will then take place and the green LED will stay on as long as the burner is alight. If the gas does not light first time, the ignitor will switch off, the gas valve will close and there will be a 60 second delay before it tries again.

Note – When the water has reached the preset temperature the green LED will switch off. As the water cools or is drawn off, the heater will automatically start the above sequence again. If the red LED starts flashing it indicates a fault condition, see fault finding and lockouts.

ELECTRICITY – The Malaga 5E has a 230V, 750W immersion heating element. The operation of the immersion heater is controlled by the same thermistor that controls the gas burner. If you wish to use the immersion heater operate the 230V switch on the control panel. The immersion heater can be used on its own or simultaneously with the gas burner to achieve a quicker heat up time.

Note – A 12V DC supply must be connected at all times.

SWITCHING OFF THE APPLIANCE – If the appliance is not in use it should be switched off using the control panel. If the heater is not going to be used for a long period of time the tank should be drained and gas supply isolated.

WATER – This appliance **must not** be connected directly to the mains water supply.

BATTERY – The heater is designed to operate on a 12V DC supply. Should the supply drop below 10V or rise above 15V, the gas valve will switch off and a fault code of 3 flashes will be displayed on the control panel.

FAULT FINDING & LOCKOUTS

WINTER OPERATION – When using the heater in winter ensure the flue is not blocked by snow or fallen leaves etc. When not in use make sure the heater is drained, especially during the winter months.

ENERGY FAILURE – in the event of an energy failure isolate the gas supply. When the energy supply has been restored clear any lockouts which may have occurred and continue normal operation.

BLOWN FUSE – The Malaga MK 5/5E is equipped with a 2A replaceable fuse to protect the PCB in the event of an overload on the 12V circuit. This is easily replaced and the location of the fuse is outlined on page 11.

MAINTENANCE

To clean and sterilise inside the water heater use diluted sterilising fluid and fully rinse through with clean water afterwards. The outside of the appliance should not normally require cleaning. If it does, isolate the electrical supplies and wipe down with a soft, damp cloth only. Allow to fully dry before reconnecting the electrical supplies.

If descaling of this appliance is required, this can be done using ‘Kettle Klear’ or an equivalent product and fully rinse through with clean water afterwards. The appliance should be checked and maintained (if required) periodically by a competent person within a maximum of 2 years according to the practice in the country where it is used and these instructions.

We recommend annual testing of gas soundness and combustion by an accredited LPG gas engineer.

The centre page of this booklet shows an exploded diagram of the appliance to aid maintenance.

The heater is equipped with an electronic diagnostic system which will detect fault conditions ranging from poor gas or DC supply to internal heater malfunctions. In the event of a failure, the red LED on the control panel will flash a number of times, pause, and repeat until switched off. Count the number of flashes and refer to the table below.

Number of Flashes	Fault	Remedy
1	No Flame Detected	Check gas supply making sure there is gas in the bottle and no blockage in the gas line. Ensure propane is used at temperatures below +5°C. Clear lockout as described below.
2	Overheat	Check there is water in the appliance. We recommend you wait at least 5 to 10 minutes to allow the heater to cool before clearing lockout as described below.
3	Low/High Supply Voltage	Minimum operating voltage is 10V, maximum is 15V, when measured at the heater. Check battery voltage. If between 10V and 15V, check connections between heater and battery. Check alternator or external battery charging. Clear lockout as described below.
5	Other / internal fault	Attempt to clear lockout as detailed below. If this fails, contact Propex directly.

Clearing Lockouts

Lockouts are cleared by moving the switch from on position to off position then back to the on position. The complete sequence of switch movements must be completed within 2.5 seconds for a lockout to be successfully cleared. If there is air in the gas line, e.g. after a gas bottle change, the water heater may require several attempts before it lights. If this does not clear the Overheat lock out remove the front cover exposing the PCB and press the red button on the manual reset overheat thermostat.

Note: A cycling of the power supply to the unit will not clear a lockout.

If problems persist contact **Propex Heatsource Ltd on 023 8058 2555**

CONNECTING THE WATER HEATER

When installing a non return valve should be fitted if necessary.

1. WATER: The Malaga 5 is fitted with 12mm plain stems to which a suitable 12mm push fit connectors should be fitted. Alternatively you can also use 12 mm I.D. reinforced, food quality, opaque or equivalent pipe with hose clips. It is important that the hot and cold connections are connected correctly and if the plastic inlet connection is removed, only a plastic replacement should be used.

IMPORTANT: The hot water outlet connection at the top of the tank must not be removed as this houses an additional internal tube which provides the air space for expansion inside the tank. The water pressure must not exceed 1.3 bar. **ALSO** do not connect this appliance to a mains water supply.

Drain/Pressure Relief Valve – Drill the appropriate sized hole in the floor close to the heater and run a piece of hose from the drain port, through the hole to the outside. Seal round the hole with silicone or similar sealant.

Water Systems – The heater will work satisfactorily on either system where the pump is controlled by a tap, micro-switch or pressure switch.

2. GAS: The gas fitting is 8mm (5/16") and a suitable compression fitting is required. An isolation tap should be fitted near to the heater and any unsupported pipe-work secured. It is recommended that a gas drop hole be positioned near to the heater and that all connections are carried out by a registered person (see Installation section on page 3) .

3. ELECTRICITY: Fit the control panel in the chosen position and route the loom down to the heater and plug into the PCB at CN27 & CN26. Connect the 2 core loom to the 12v supply at CN24 and route to the heater making sure the polarity is correct. NOTE there is one less core on the loom used on the Malaga 5 and is supplied with a single on/off switch, whereas the Malaga 5E has 2 x 2 position switches to allow independent operation of gas or electric.

Malaga 5E only – The 3 core mains cable should be connected to a 230V AC – 5 amp double pole fused spur.

Note: This appliance must be earthed.

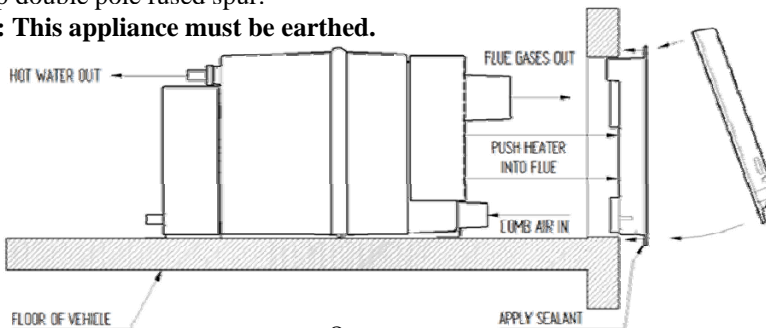

INSTALLATION INSTRUCTIONS

A competent person should install the appliance in accordance with the appliance installation instructions and should consider any relevant regulations in the country where the appliance is installed. For this appliance in Europe the standard is BS EN 1949:2002 (Specification for the installation of LPG systems for habitable purposes in leisure accommodation vehicles and in other road vehicles).

Installation and servicing of this appliance must only be carried out by persons registered with the Gas Safety Register (GB), or the relevant national organisation.

Prior to installation check the compatibility of the data plate information with the LPG supply requirements of the vehicle.

This appliance must be installed in accordance with the current regulations. In the United Kingdom the installation must be in accordance with BS6501 Pt 1 1978, BS5482 Pts 1 & 2 1977 and BS5440 Pt 2 1990.

The Malaga 5 Water Heater is designed to be floor mounted and flues through a vertical section on an external wall. Normally the heater would be fitted in a bed-box or locker allowing access to the heater with suitable room for service and inspection. Structural sections within the vehicle should not be damaged. The flue terminal should not be fitted at the side of the caravan/motor home where an awning may be fitted.

FLUE – Using masking tape, fix the template to the inside of the vehicle and drill a pilot hole at position X. Remove the template and tape it to the outside of the vehicle ensuring that the template is square and that the centre lines up with the hole drilled from the inside.

Drill a 10mm hole at positions A and, using a jigsaw, cut out the hole. The hole in the wall must be battened to secure inner and outer skins.

Note: When battening the finished hole must be 240mm x 135mm. Run a bead of silicon rubber, or similar sealant, around edge of the rear side of the flue terminal, position into cut-out in wall and secure with 6 screws (No.8 x 3/4") provided and remove excess sealant. Clip the top of the flue cover onto the flue terminal and secure with 2 screws (No. 6 x 1/2") provided.

WATER HEATER – Remove the floor covering (e.g. carpet etc) from the area where the heater will stand – 450mm inward from the wall and 320mm wide. Draw a line on the floor from the centre of the flue, 570mm into the vehicle. Slide the heater through the flue seals until the stop position is reached. Make sure both flue and air intake pass through the lip seals.

Measure 115mm from right hand side of rear foot and line up with line on floor – screw heater to the floor.

EXPLODED DIAGRAM OF MALAGA 5/5E

This diagram is to be used for reference when carrying out any maintenance on the appliance.

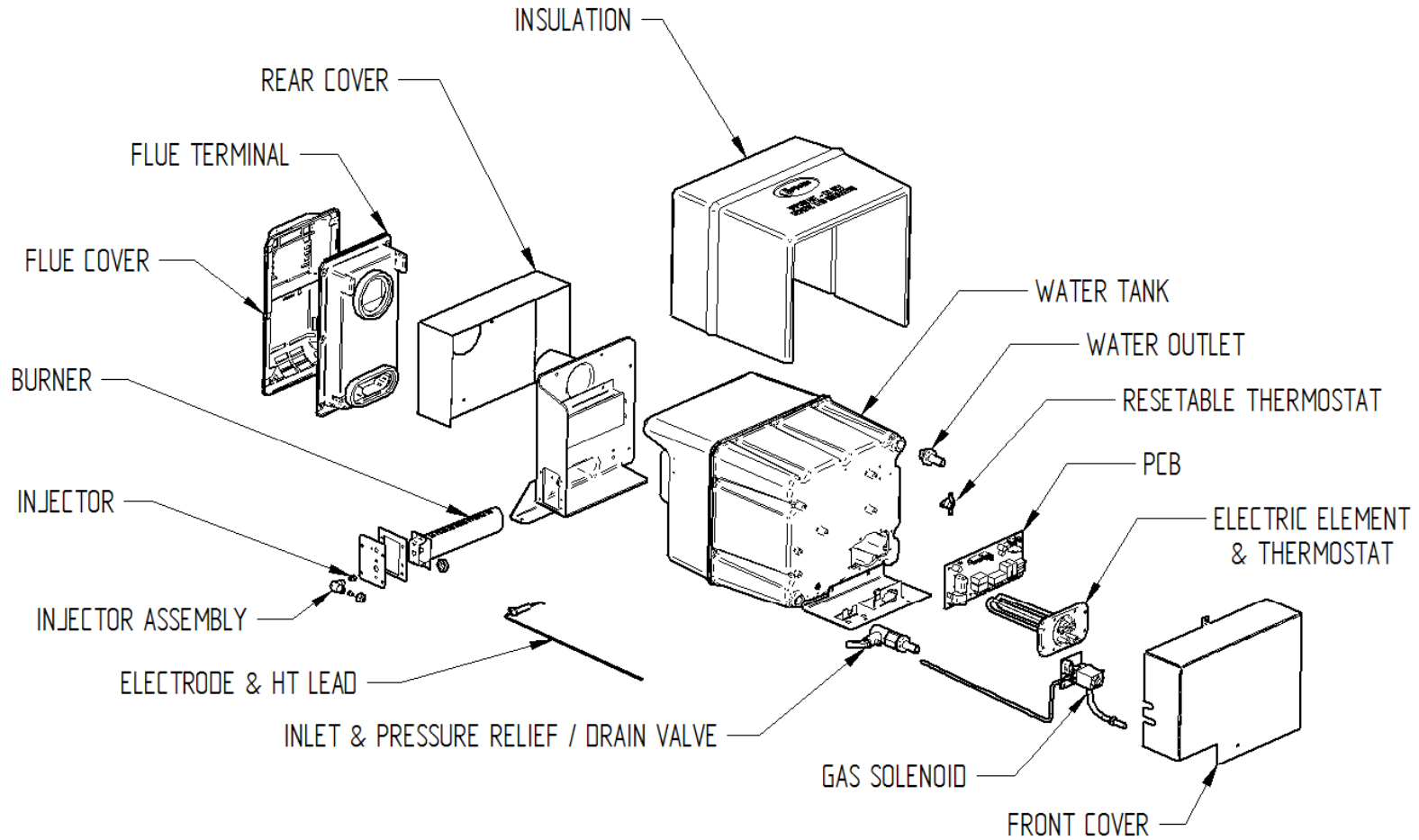

Note: "ELECTRIC ELEMENT & THERMOSTAT" is only present on Malaga 5E. Malaga 5 will have a blanking plate in place of this.